

# USER MANUAL

Smart Safe OX & OX Pro

## What's Included

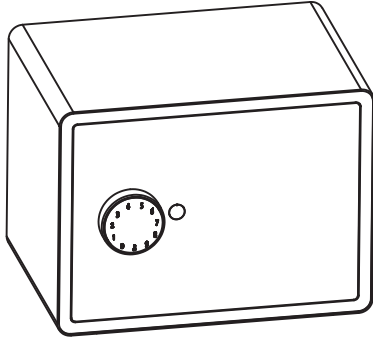

Smart Safe OX x 1

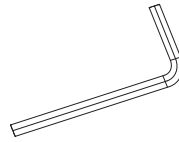

M6 Screw Driver x 1

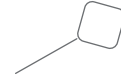

Reset Tool x 1

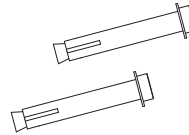

M6 Wall-Mount Screw x 2

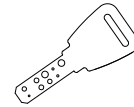

Mechanical Key x 2



Hello Card x 1

## Specification

<b>Model</b>	OX & OX Pro
<b>Material</b>	Galvanized steel
<b>Battery</b>	4×AA Battery
<b>Unlock Mechanism</b>	Bluetooth, PIN Code, App, Mechanical Key

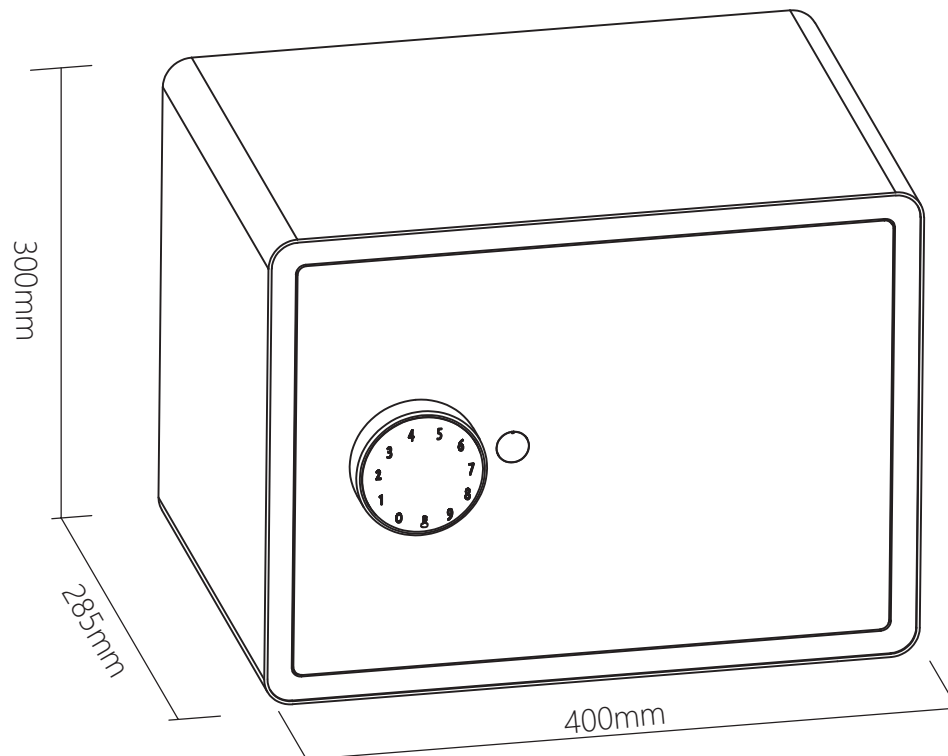

# Features

## Lock&Unlock



### **Administrator Unlock**

Set a Master Administrator PIN for Unlocking, settings, operations etc. And only the administrator could change the administrator PIN code.



### **User Unlock**

This Smart Safe allows to add up to 200 user PIN codes for your family and friends.

## Mobile Control



### **Bluetooth Unlock**

With your Mobile app you could unlock the Safe by swiping the  to the right.



### **Mobile Administrator**

Set Administrator PIN Codes on your Mobile to unlock, add members, delete members, etc.



### **Remote Sharing**

You could generate offline code through mobile App and let your friends and family access the Safe.

## Battery



### **Battery Life**

The battery lifetime will be 12 months for operating.



### **Low Consumption**

BLE broadcasting turns to sleep mode if no operation.



### **Low Battery**

When the batteries run out of power, system will remind you to replace the batteries.

## Burglar Alarm



The alarm will be activated if anyone attempts to destroy the Safe, and the High decibel buzzer will be turned on.

## Emergency



### **Emergency Unlocked**

When the power is down, we can use Mechanical Key to open the Safe.



### **System Lockdown**

The lock will be lockdown for 5 minutes if continuously enter wrong passwords for 5 times.

## Installation

>. Please use the 2 mounting screws to fix the safe on your wall or cabinet.

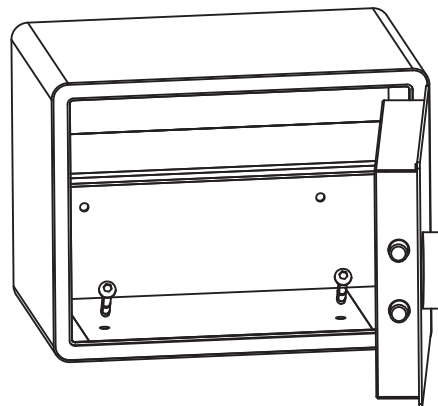
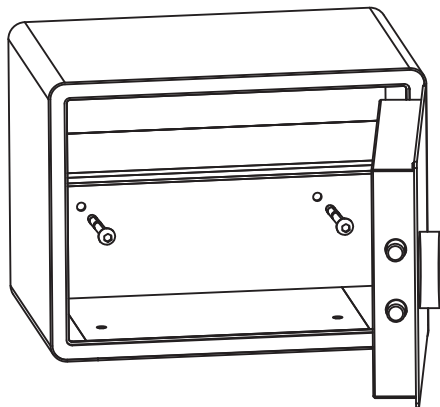

## Quick Start

### Step 1 > Install Battery

>. Put 4 × AA Battery into the battery dock.

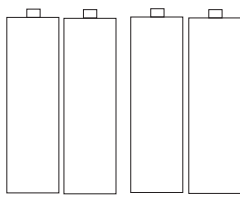

Reset Button

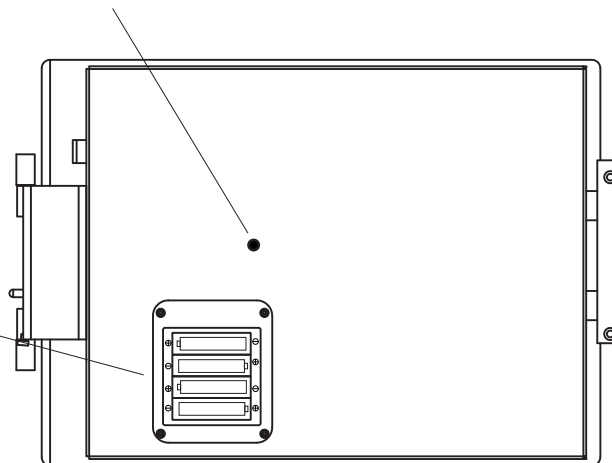



## Step 1 > Change Admin Password-Initial Admin Password:123456

**Administrator is required to reset the admin code before adding other user codes.**

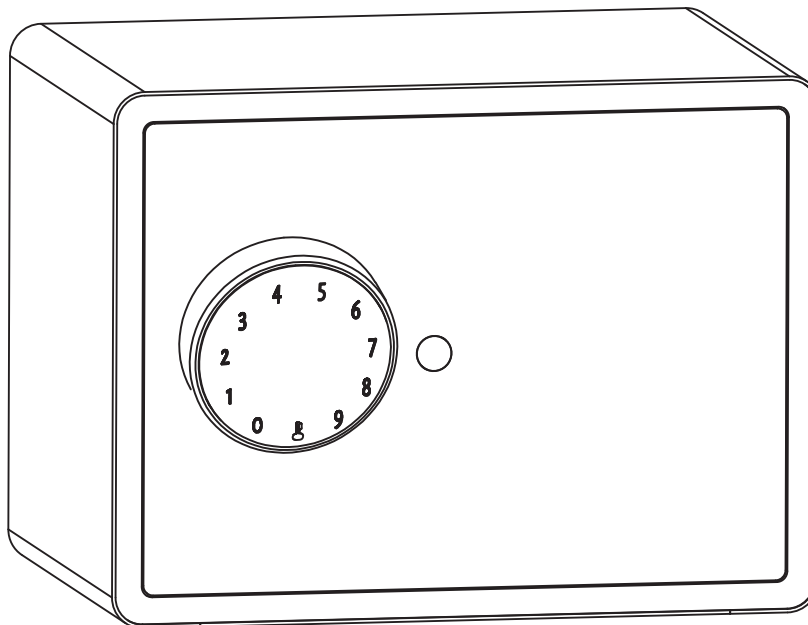
>1. Tap  and hold for 3 seconds and release, you will be hearing a confirmation sound.



>2. Right after the **a confirmation sound** please key in:

Initial admin code+ + new admin code+ +new admin code again+ , when you hear a confirmation sound the admin code has been changed.

## Step 2>Download Mobile App

>1. Scan QR Code below to download the App and turn on your mobile Bluetooth. You can also choose to download other App supported by Tuya.



## Step 3>Add Device

### Activate Bluetooth to enter pairing mode

> 1. Tap 🔑+ 9 + 🔑+ admin code + 🔑, when you see the light slowly blinks in blue then you are ready to pair

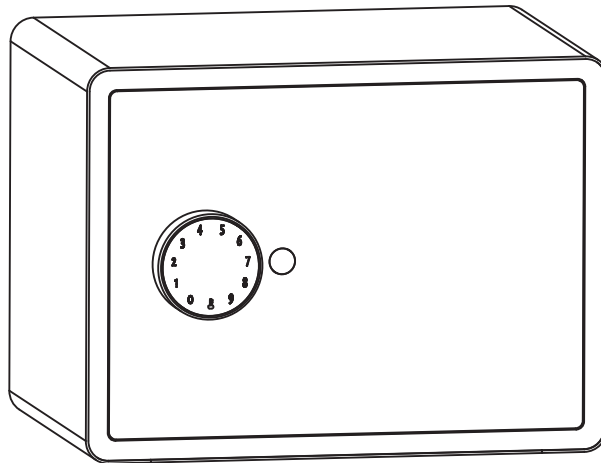

>2. Go to App Home page, click "Add Device" or click "+" on the upper right.

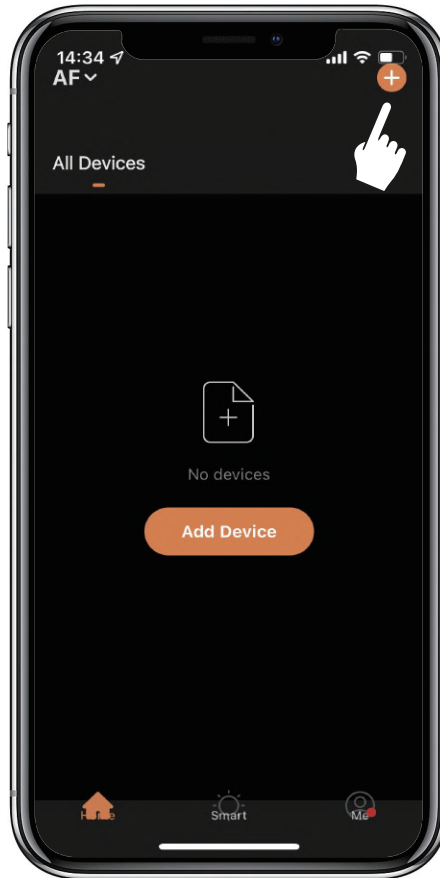



>3. You will see the detected device and click "Go to add".

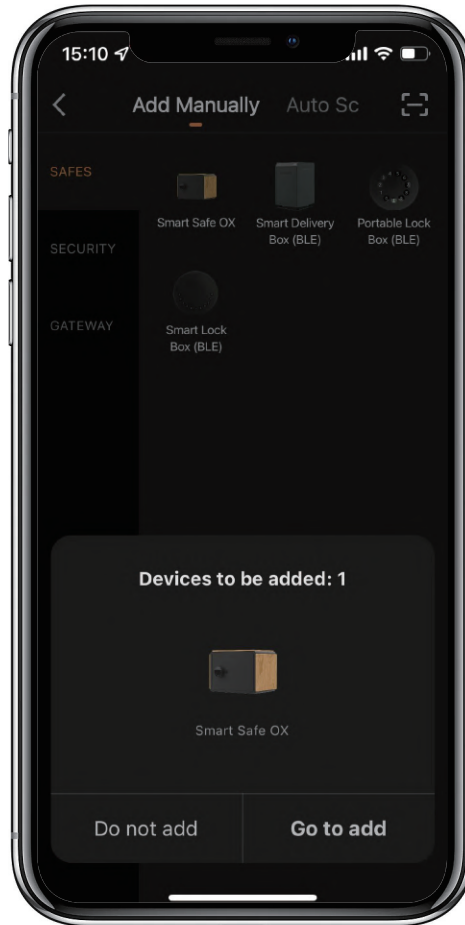

>4. Connecting, you need to wait for a few seconds to let it finish.

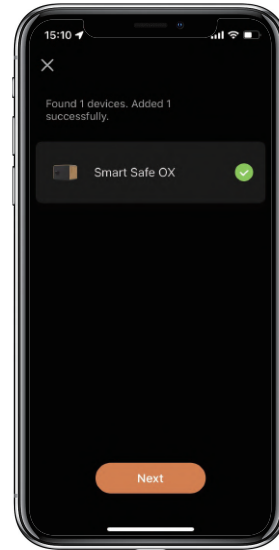
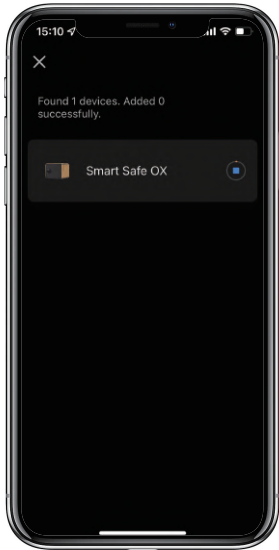

>5. Device added

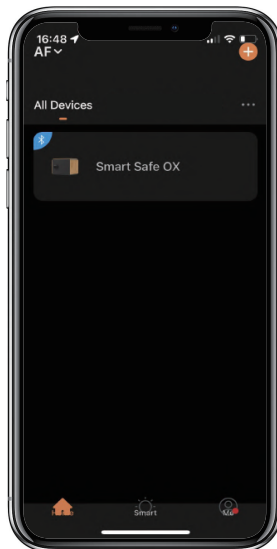

# Mechanical Instructions

## Password & Factory Mode:

**Administrator is required to reset the admin code before adding other user codes.**

### 1. Password Length

☒ Password must be 6 digits (no more or less)

### 2. Add User Password

- ☒ Tap **⏏** + 0 + **⏏** until the blue light blinks
  - >. Enter admin password + **⏏**
  - >. Enter new user password + **⏏**
  - >. Enter new user password again and press **⏏**
  - >. When the **⏏** (Enter button) blinks in green, user password has been set.

### 3. Delete User Password

- ☒ Tap **⏏** + 2 + **⏏** until the blue light blinks
  - >. Enter admin password and press **⏏**
  - >. Enter the user password you want to delete and press **⏏**
  - >. Enter the user password you want to delete again and press **⏏**
  - >. When the **⏏** (Enter button) blinks in green the password has been deleted.

### 4. Delete All User Passwords

- ☒ Tap **⏏** + 00000 + **⏏** until the blue light blinks
  - >. Enter admin password and press **⏏**
  - >. When the **⏏** (Enter button) blinks in green, all user passwords have been deleted.

### 5. System Lock-down

☒ The Smart Safe will Lock-down for 5 minutes if entering wrong password continuously 5 times.

### 6. Virtual digits-Anti Peeping

☒ Add any digits before and after the correct password the Safe unlock as always.

### 7. Reset Factory Mode

☒ Use the reset tool press and hold the reset button for 5 seconds until a long beep.

## Bluetooth broadcasting & re-connecting:

☒ Bluetooth will turn to sleep mode and lights out if no operations within 1 minute.

☒ Tap any key to activate the Bluetooth, App & Device will get reconnected each other.

# App Instructions

## How to unlock:

- ☒ You will see all devices on the home page.
- ☒ Tap the Smart Safe OX to start operating.
- ☒ Swipe the 🔑 to the right to unlock.

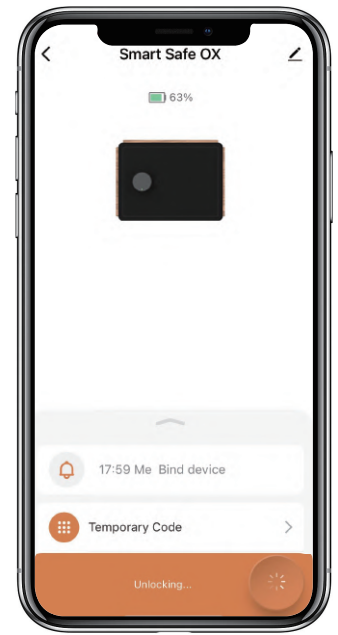
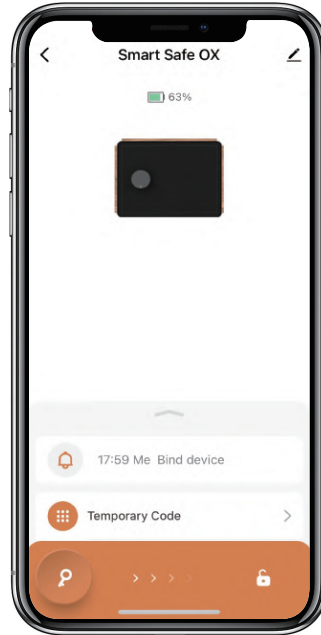
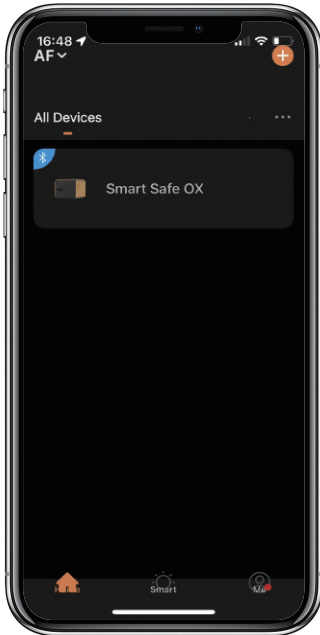

## How to get Temporary code:

- ☑ Tap "Temporary Code"
- ☑ Tap "Obtain Password" to get Dynamic code which is valid for 5 minutes.
- ☑ Tap "OK" to confirm and also can Tap "Share" to share this code with family or friend.

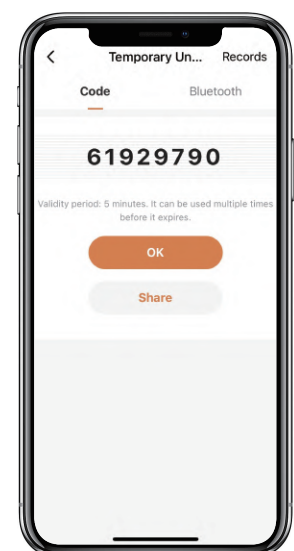
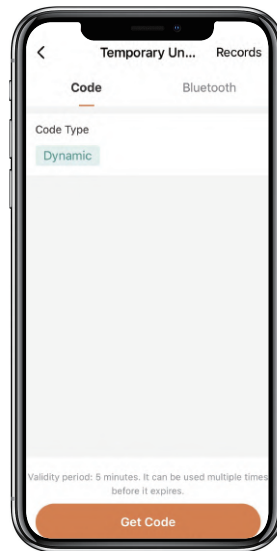
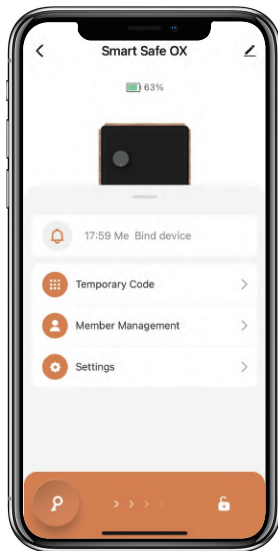

## How to add Members:

- ☑ Tap "Member Management" to add family member or others.
- ☑ Tap "+" to add member and edit member's information and save.
- ☑ Member will receive an invitation on the App, after he/she accept it, Admin can find the member in the list.

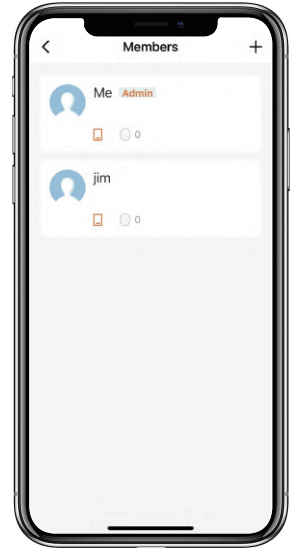
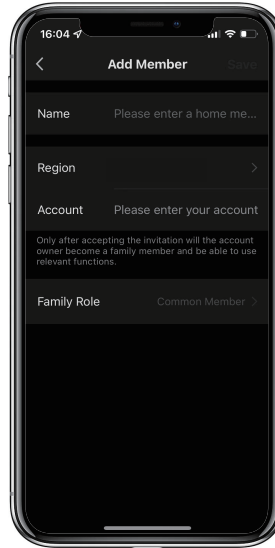
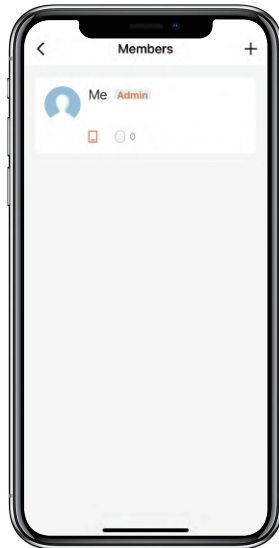
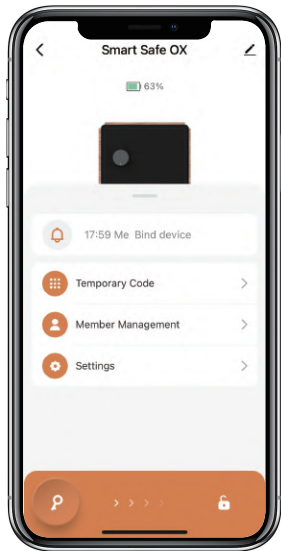

## How to add Permanent code:

- ☒ Tap the Admin "Me" to add Permanent code.
- ☒ Tap "Add" to enter the Permanent code you want or get Random Permanent code and save.
- ☒ You are able to use the Permanent code to unlock the Safe.

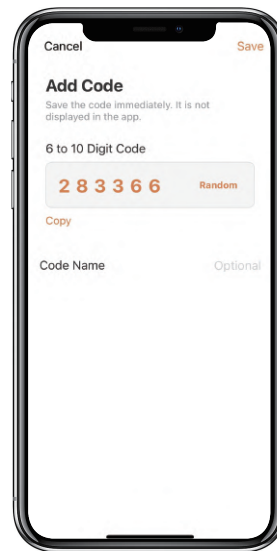
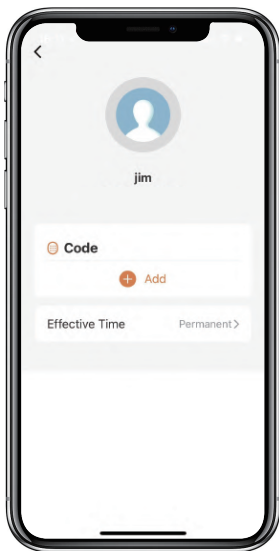
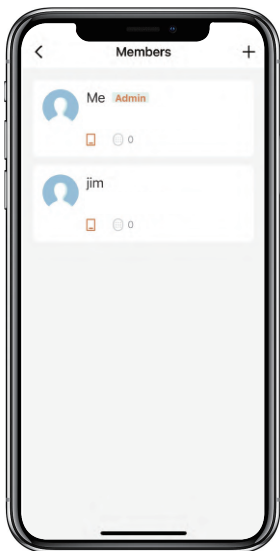

## How to manage Members:

- ☑ Tap the Member you want to manage.
- ☑ Tap "Add" to set the Permanent code for the Member and save.
- ☑ Tap "Effective Time" to set this Member is Permanent or Custom and save.
- ☑ Set the validity period of Custom Member(Year/Month/Day/Hour/Minute).
- ☑ Members don't have access to Admin.

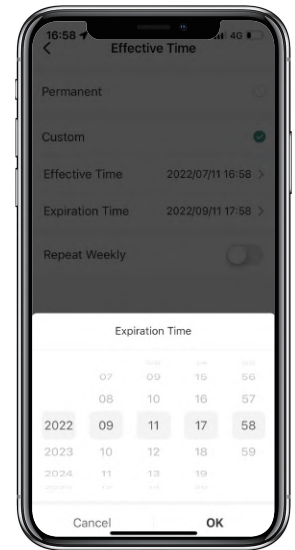
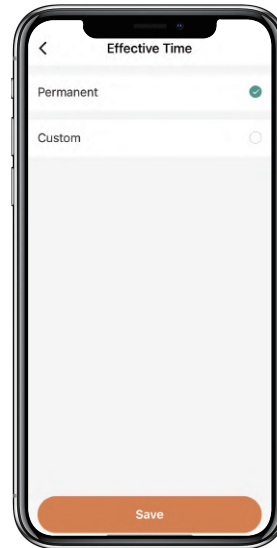
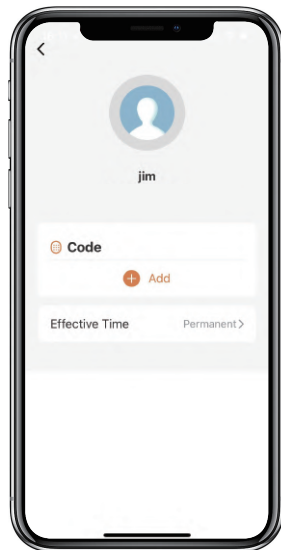
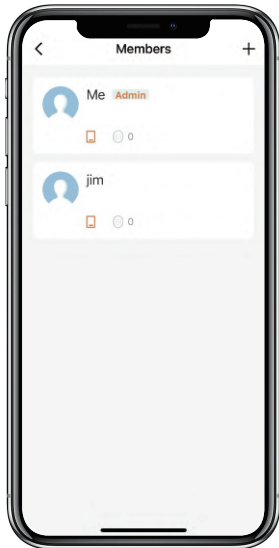



## How to check Opening Log:

☒ Tap  to check the Log.

☒ You will find out when and whom opened the Safe.

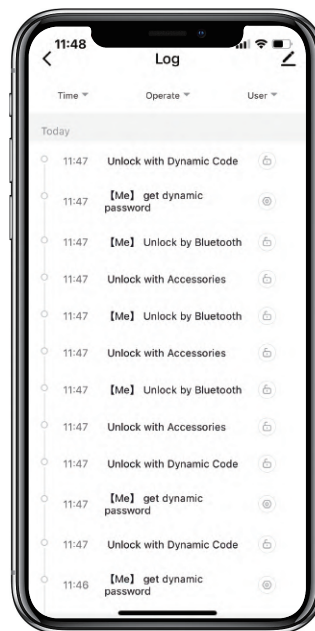

## How to enable Alarm :

- ☒ Tap "Settings" to enable the "Arm Away"
- ☒ The alarm will be triggered if anyone attempts to destroy the Safe

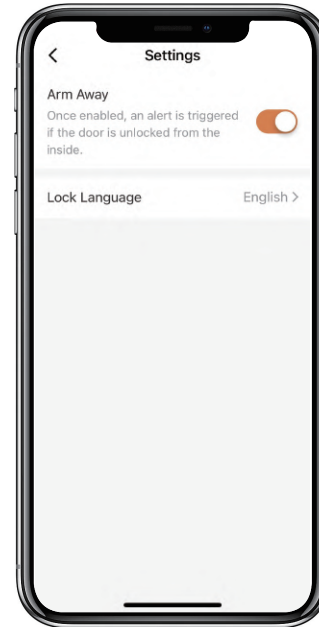
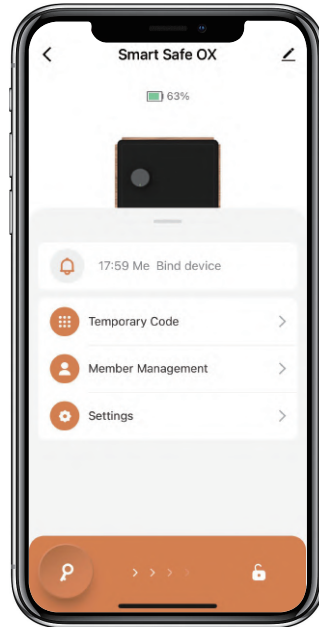

## Gateway Instructions

**If you have a Gateway supported by Tuya, it is available to connect the Gateway with our App.**

- ☒ With the Gateway, you will receive the notification on time via the internet when the alarm is triggered.

## How to enable Remote Unlock :

- ☒ Tap "Settings" to enable the "Remote Unlock"
- ☒ You will be able to unlock the Safe remotely via the internet.