

# KeySafe Smart

# KeyBox K12

# USER MANUAL V4.0+

# **BOPP.**

Lösungen statt nur Produkte

# What's Included

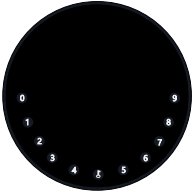

**1 x KeyBox**



**1 x HELLO Card**

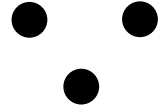

**3 x Screw Caps**

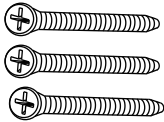

**3 x Mounting Screws**

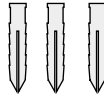

**3 x Screws Anchors**



**1 x Reset Tool**

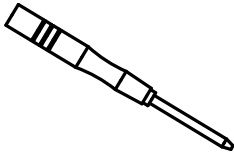

**1 x Screw Driver**

## What are the differences

- >1. OTA upgrade: Support remote software upgrade
- >2. App: Simplified user interface / features
- >3. Strength: increased from two wall mounting screws to three for wall fixing, thus enhancing the stability

# Specification

<b>Model</b>	K12
<b>Material</b>	Body Zinc Alloy, SUS304
<b>Battery</b>	4 x AAA Alkaline Battery
<b>Unlock Mechanism</b>	Bluetooth, PIN Code, App
<b>Jump Start</b>	USB-C

**Front**

**Inside**

**Back**

120mm ( 4- 7/10'' )

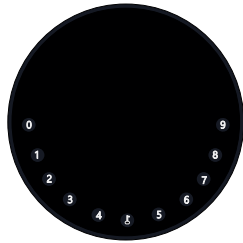

120mm ( 4- 7/10'' )

120mm ( 4- 7/10'' )

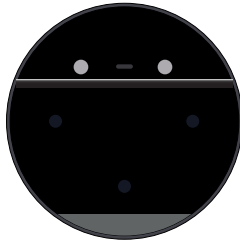

**Depth**

22mm ( 4/5 '' )

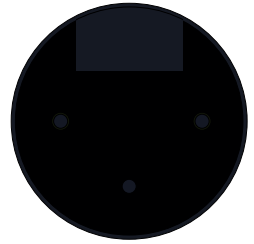

120mm ( 4- 7/10'' )

# Features

## Lock&Unlock



### Administrator Unlock

Set a Master Administrator PIN for Unlocking, settings, operations etc. and only the administrator could change the administrator PIN code.



### Anti-peeping

Add up to 10 digits before and after PIN code to intensify your PINs.

## Mobile Control



### Bluetooth Unlock

With your Mobile you could unlock the KeyBox by Swiping the "👉" to the right.



### Mobile Administrator

Set Administrator PIN Codes from your Mobile to unlock, add users, delete users, etc.

## Battery



### Battery Life

4 AAA batteries, the life cycle will be more than 12 months, please use good batteries.



### Low Consumption

BLE broadcasting turns to sleep mode if no operations.

## Emergency



### Jump Start

When the power is down and use USB-C to jump start the lock and get it unlocked

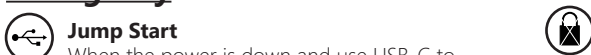

### System Lockdown

The lock will be lockdown for 5 minutes if continuously enter wrong PINs for 5 times.



### User Unlock

This KeyBox allows to add up to 100 user PIN codes for your family, friends and visitors.

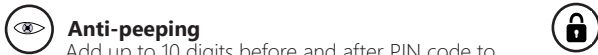

### Auto Locking

If there are no opening motion in 10 seconds the box will be automatically locked.



### Offline Unlock

You could generate offline code through mobile App, for scheduled access, parcel delivery, housekeeping, etc.



### OTA Upgrade

Upgrade online, Fix bugs, Update functions and optimize user experience.



### Low Battery

When the battery runs out of power, system will remind you to replace the batteries.

## Quick Start

### Step 1 > Install Battery

>. Remove the (4) screws on the battery cover

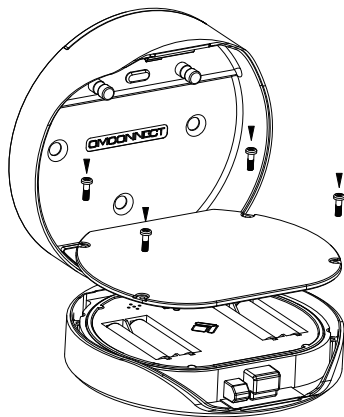

>. Put 4 AAA batteries into the battery dock.

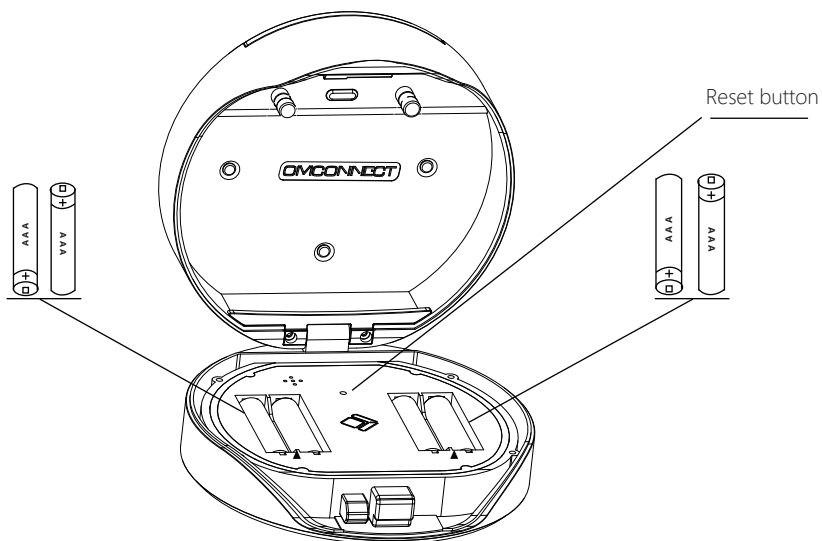

## Step 2>Change Admin Password-Initial Admin Password:123456

>1. Press  and hold for 3 beeps

>2. Right after the 3 beeps please key in:

Initial Admin Password + +new admin password+ +new admin password+ 

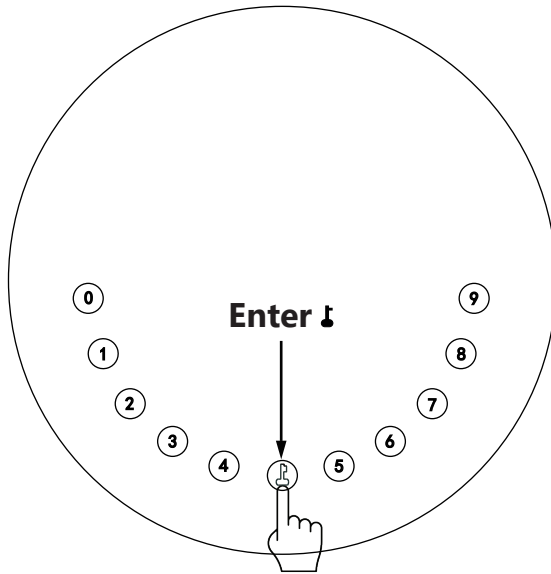

## Step 3>Download Mobile App

>1. Scan QR Code below and download the App and turn on your mobile Bluetooth, you can also choose to download other App supported by Tuya.



## Step 4>Add Device

Activate Bluetooth to enter pairing mode

> 1. Press **🔑** +9+ **🔑** and enter Admin password + **🔑** , when the light slowly blinks in blue the KeyBox is ready to pair.

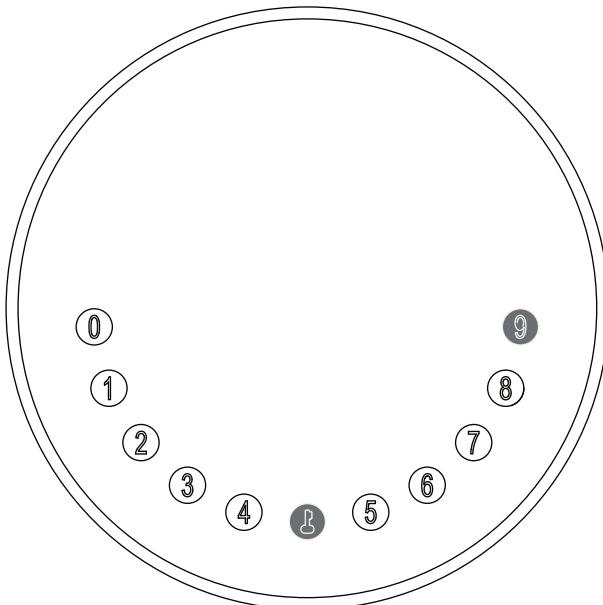

>2. Go to App Home page, click Add Device or click "+" on the upper right.

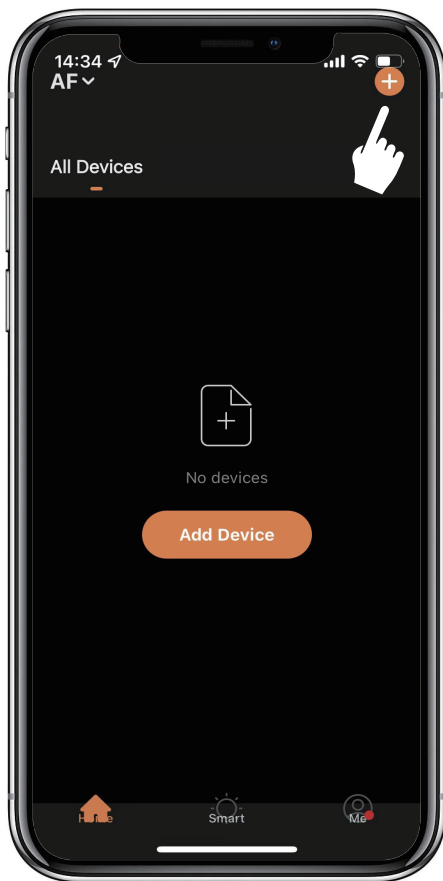



>3. You will see the detected device and click "Go to add".

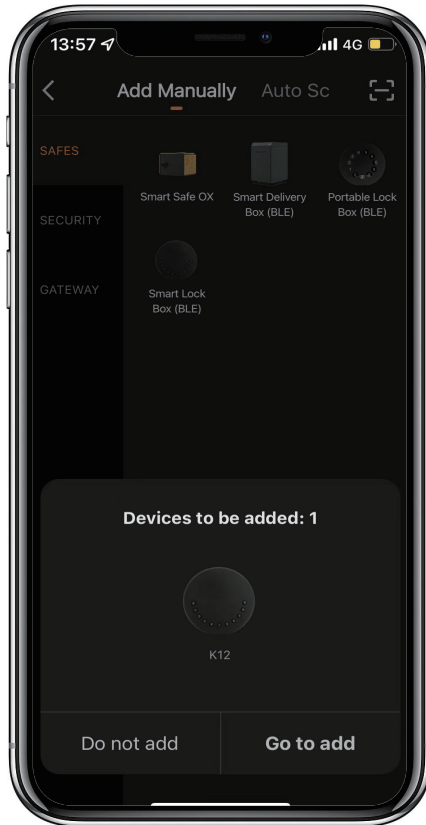

>4. Connecting, you need to wait for a few seconds to let it finish.

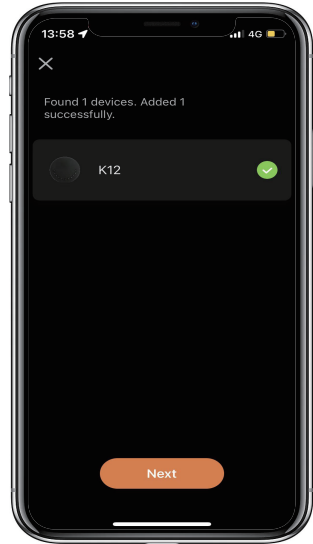

>5. Device added

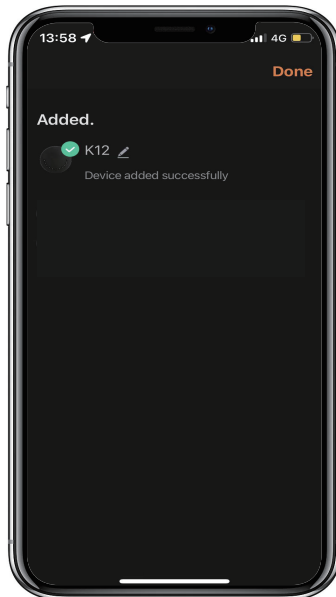

# Mechanical Instructions

## Password & Factory Mode:

### 1. Password Length

Password must be 6 digits (no more or less)

### 2. Add User Password

Press **⏏** + 0 + **⏏** until the blue light blinks

> . Enter admin password + **⏏**

> . Enter new user password + **⏏**

> . Enter new user password again and press **⏏**

> . When the **⏏**(Enter button) blinks in green, user password has been set.

### 3. Delete User Password

Press **⏏** + 2 + **⏏** until the blue light blinks

> . Enter admin password and press **⏏**

> . Enter the user password you wish to delete and press **⏏**

> . Enter the user password again and press **⏏**

> . When the **⏏**(Enter button) blinks in green the password has been deleted.

### 4. Delete All User Passwords

Press **⏏** + 00000 + **⏏** until the blue light blinks

> . Enter admin password and press **⏏**

> . When the **⏏**(Enter button) blinks in green all passwords have been deleted.

### 5. Virtual digits-Anti Peeping

Add any digits before and after the correct password the KeyBox unlock as always

### 6. System Lockdown

KeyBox will Lockdown for 5 minutes if entering wrong password continuously 5 times

### 7. Reset Factory Mode

Press and hold the reset button for 5 seconds and with a long beep

## Bluetooth broadcasting & re-connecting:

Bluetooth broadcasting will turn to sleep mode if no operation within 1 minute.

Press any key to activate the Bluetooth, App&Device will get reconnected each other.

# App Instructions

## How to unlock:

- You will see all devices on the home page.
- Tap the Smart Key Box to start operating.



- Swipe the  to the right to unlock.

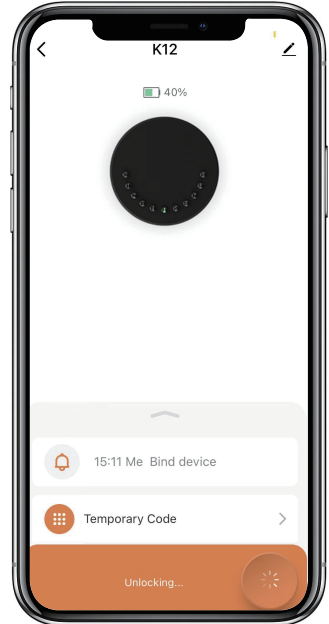
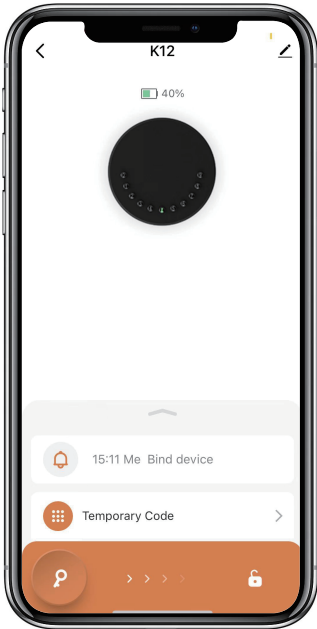

## How to get Temporary code:

☒ Tap "Temporary Code"

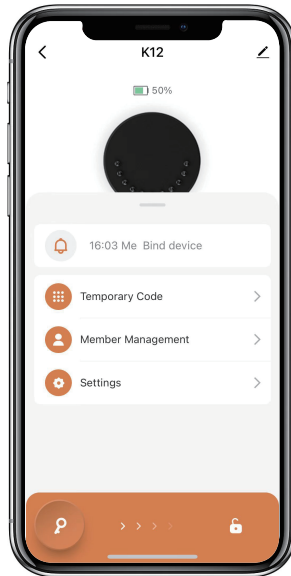

☒ Tap "Obtain Password" to get Dynamic code which is valid for 5 minutes.

☒ Tap "OK" to confirm and also can Tap "Share" to share this code with family or friend.

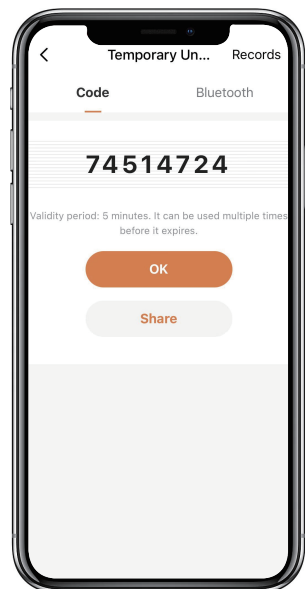
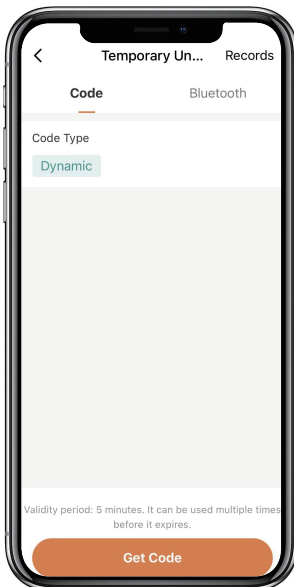

## How to add Members:

☑ Tap "Member Management" to add family member or others.

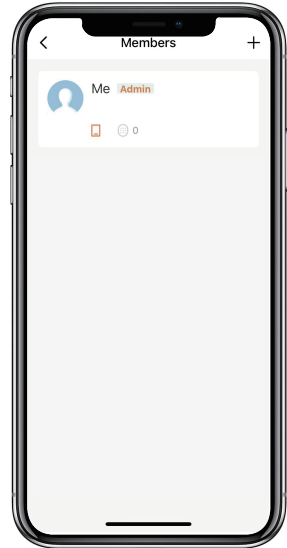
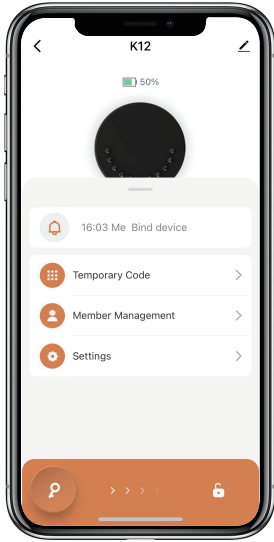

☑ Tap "+" to add member and edit member's information and save.

☑ Member will receive an invitation on the App, after he/she accept it, Admin can find the member in the list.

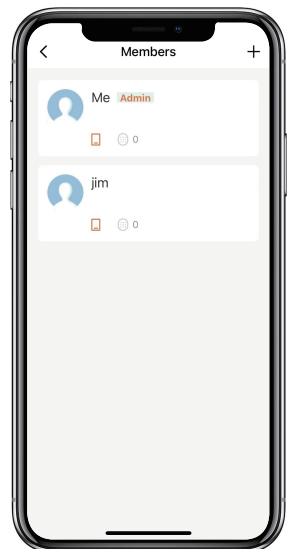
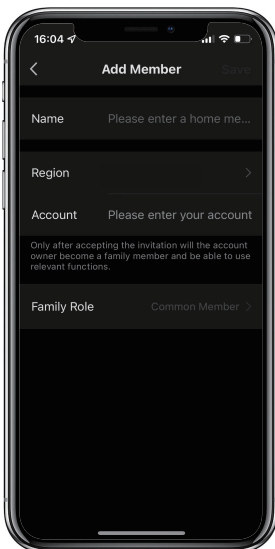

## How to add Permanent code:

☑ Tap the Admin "Me" to add Permanent code.

☑ Tap "Add" to enter the Permanent code you want to set or get Random Permanent code and save.

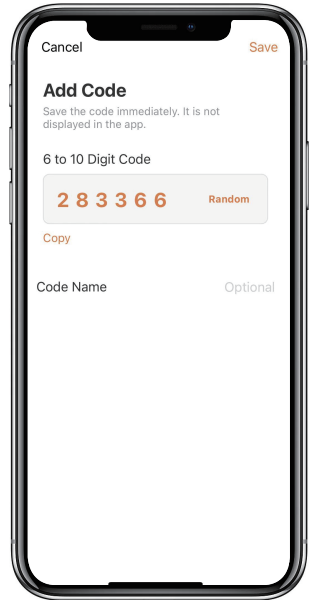
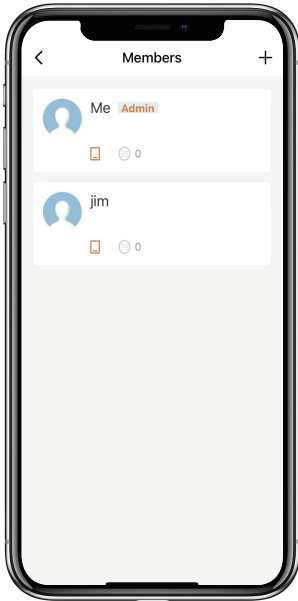

☑ You are able to use the Permanent code to unlock the device.

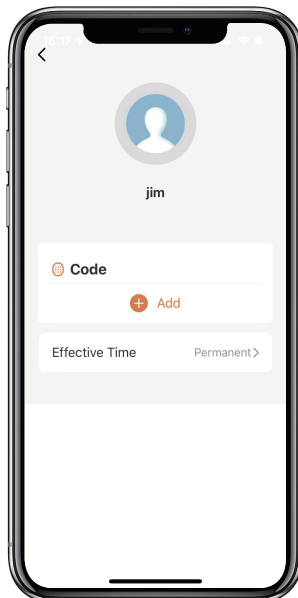

## How to manage Members:

☑ Tap the Member you want to manage.

☑ Tap "Add" to set the Permanent code for the Member and save.

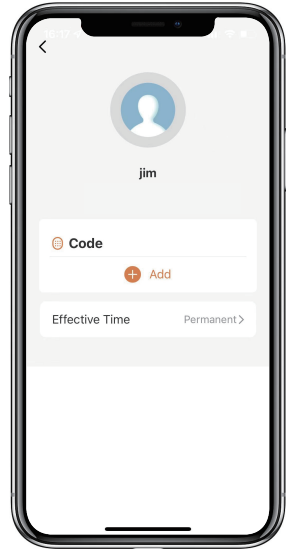
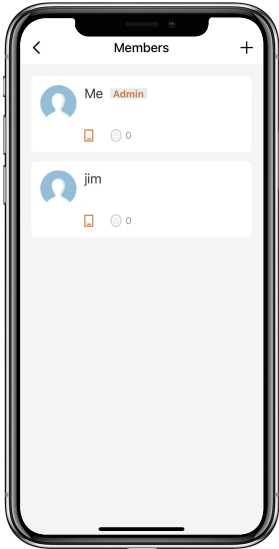

☑ Tap "Effective Time" to set this Member is Permanent or Custom and save.

☑ Set the validity period of Custom Member(Year/Month/Day/Hour/Minute).

☑ Members have no permission to access admin.

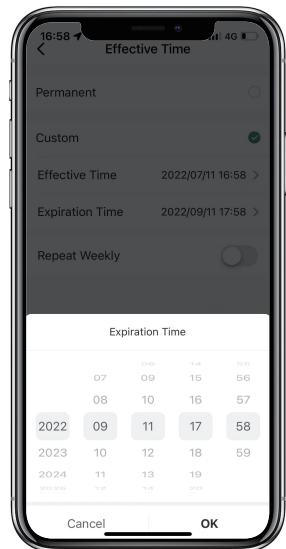
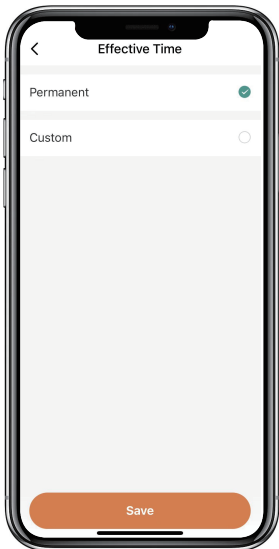



## How to check Opening Log:

☑ Tap  to check the Log.

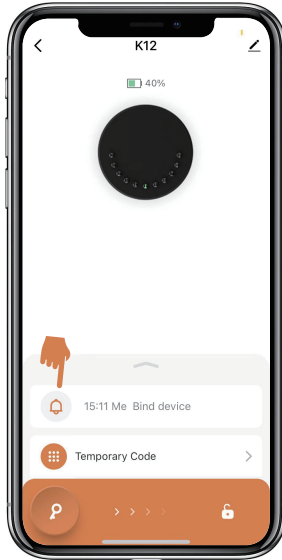

☑ You will find out when and whom opened the Keybox.

